



ANGLO

REINFORCEMENT
YOU CAN TRUST



ANGLO EUROPEAN
IMPORT-EXPORT LTD



ALUMINIUM COUPLER

Anglo European is now the UK's foremost supplier of galvanised reinforcement for the trade window fabricator. Since opening in 1989, Anglo has grown its reputation on high quality manufacturing, rapid delivery and professional customer service.

The success of the business has been built on supplying quality products, at competitive prices, backed with unrivalled levels of service and turnaround times.

Investments in manufacturing equipment, logistic solutions and employees have allowed Anglo to continue expanding its customer base and deliver efficiencies back to the marketplace.

Operating from a two acre site in Newton Heath, Manchester, we service the whole of the UK and Ireland with bar length and cut to size palletized reinforcement for the PVC-u industry.

Today, 23 years on we are still as dedicated as ever, and are constantly striving to improve our product range, which now stands at 200 plus sections. Coupled with our bespoke systems and traditional aluminium profile products, we believe Anglo can provide a complete solution to your particular reinforcement needs.

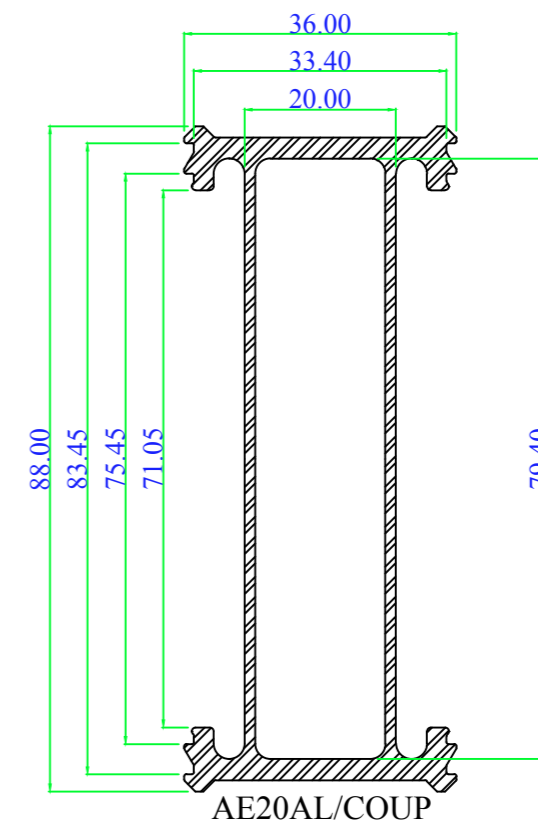

Tel: 0161 231 2354 | Fax: 0161 220 3766

Anglo European Import Export Ltd, 228 Briscoe Lane, Manchester M40 2XG
enquiries@anglo-european.net www.anglo-european.net



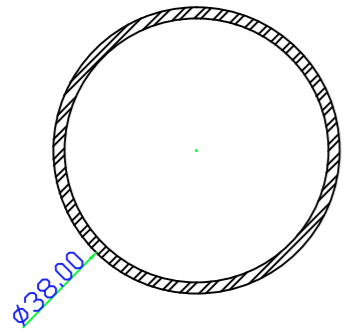

AE383

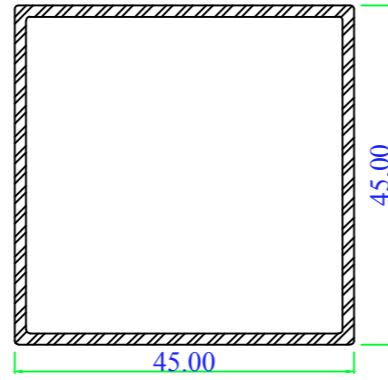

AE4545/6

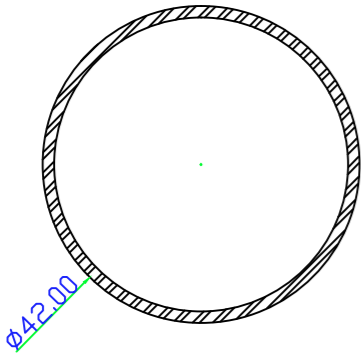

AE360

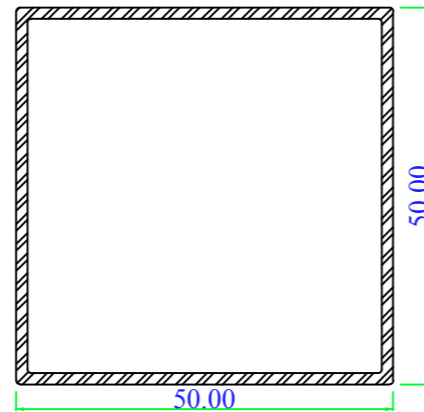

AE90B

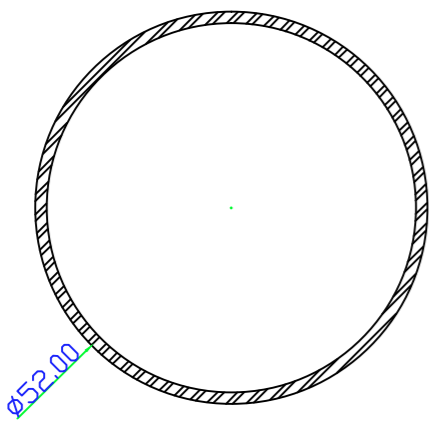

AE522/6

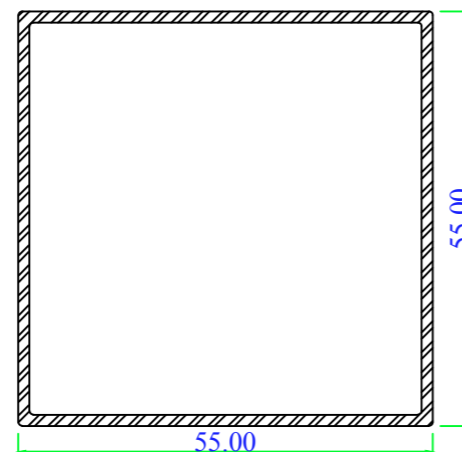

AE5555/6

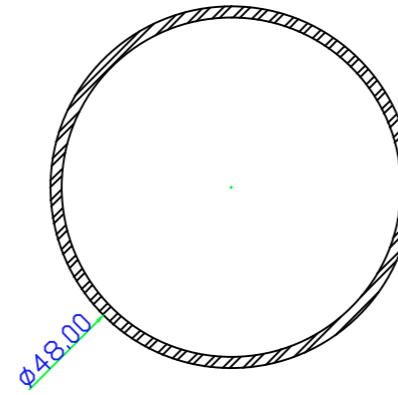

AE482/6

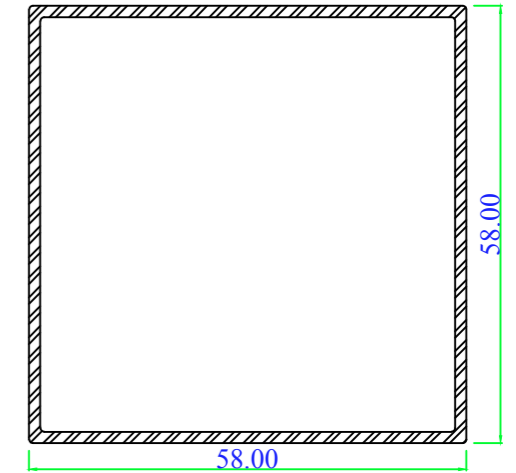

AE1684/6

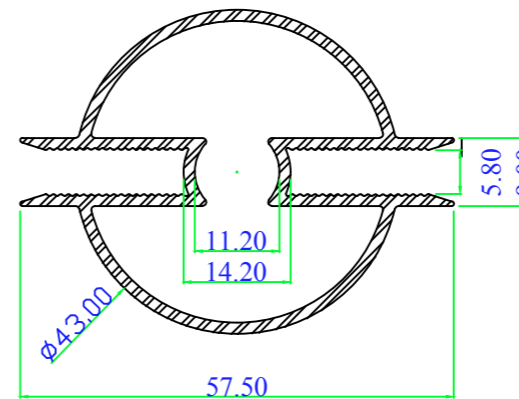

AE44AL/VAL

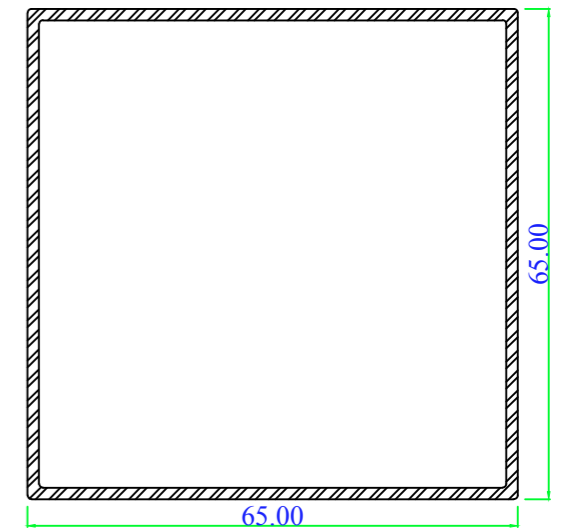

AE6565/6

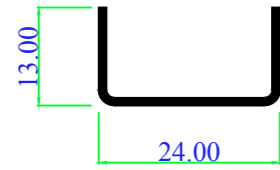

AE2513GS

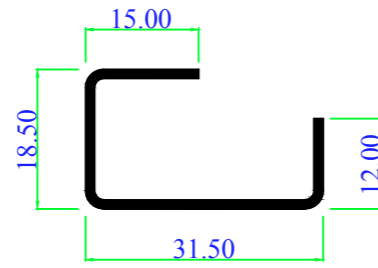

AE3703GS/5

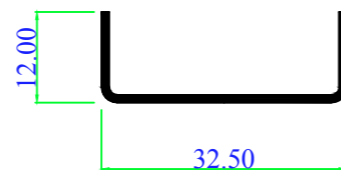

AE3GS

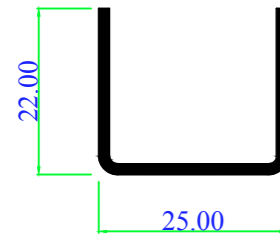

AE2522GS

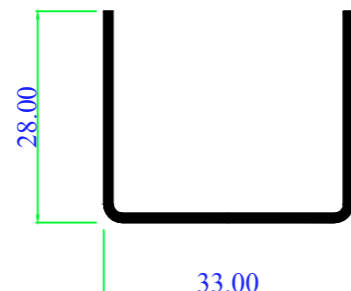

AE3328GS

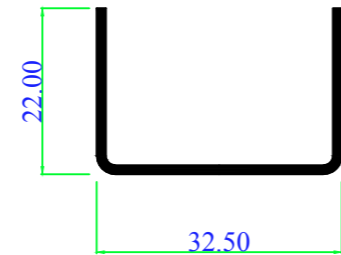

AE2334GS

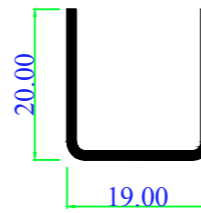

AE1620GS

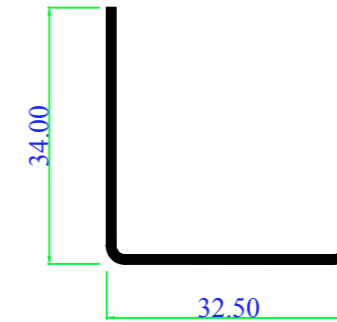

AE3434GS/57

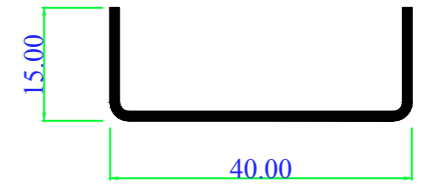

AE4015GS

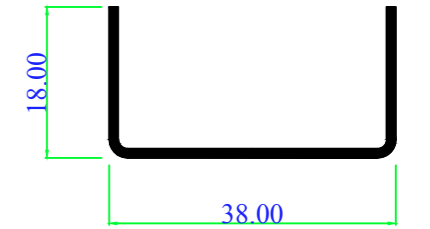

AE4020GS /
AEBR06S

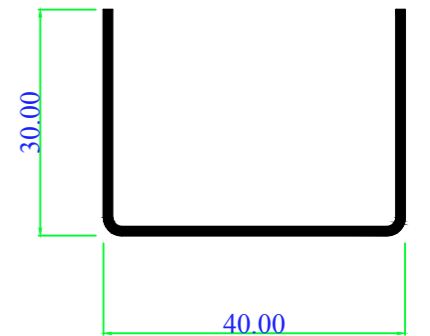

AE4030GS

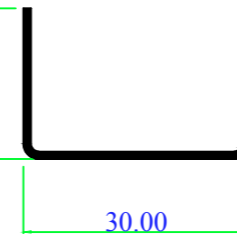

AE3020GS

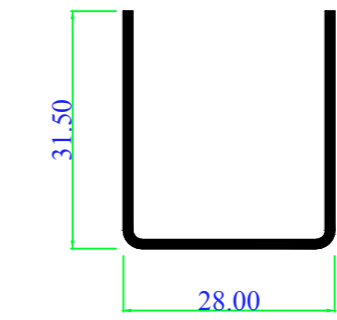

AE2832GS

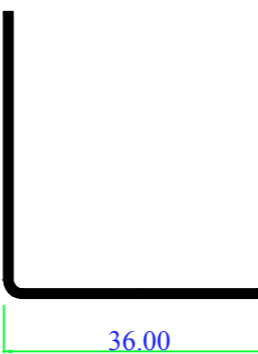

AE3540GS

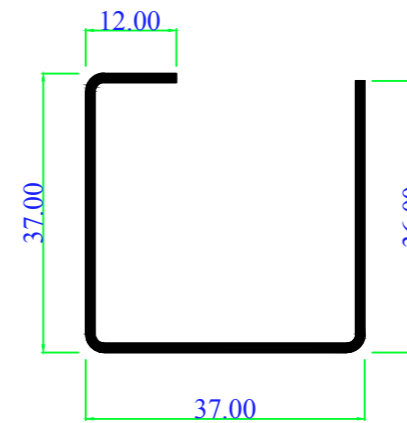

AE3702GS/5

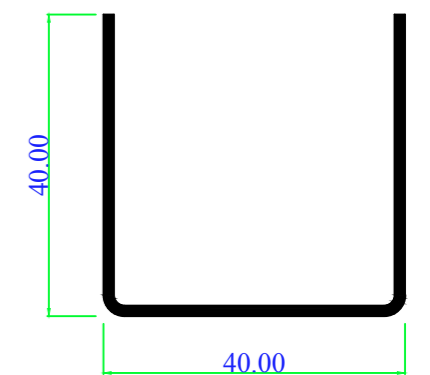

AE4040GS

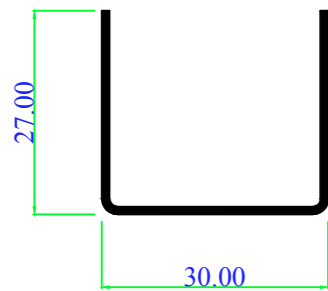

AE3028GS

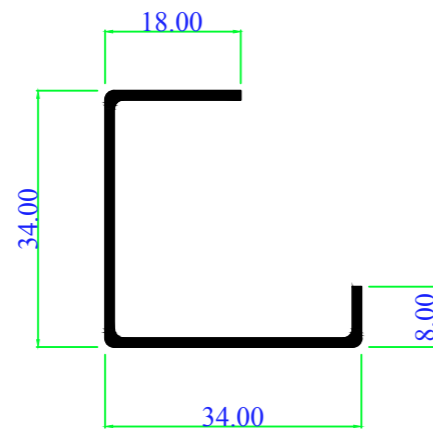

AE3701GS/57

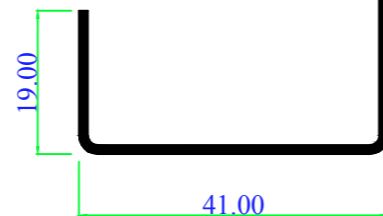

AE1934GS

General Profile Tolerance \pm C.5mm
Angular Tolerance \pm 1.0 Deg
Straightness Tolerance L/600
Length Tolerance +10mm / -10mm

General Profile Tolerance \pm C.5mm
Angular Tolerance \pm 1.0 Deg
Straightness Tolerance L/600
Length Tolerance +10mm / -10mm

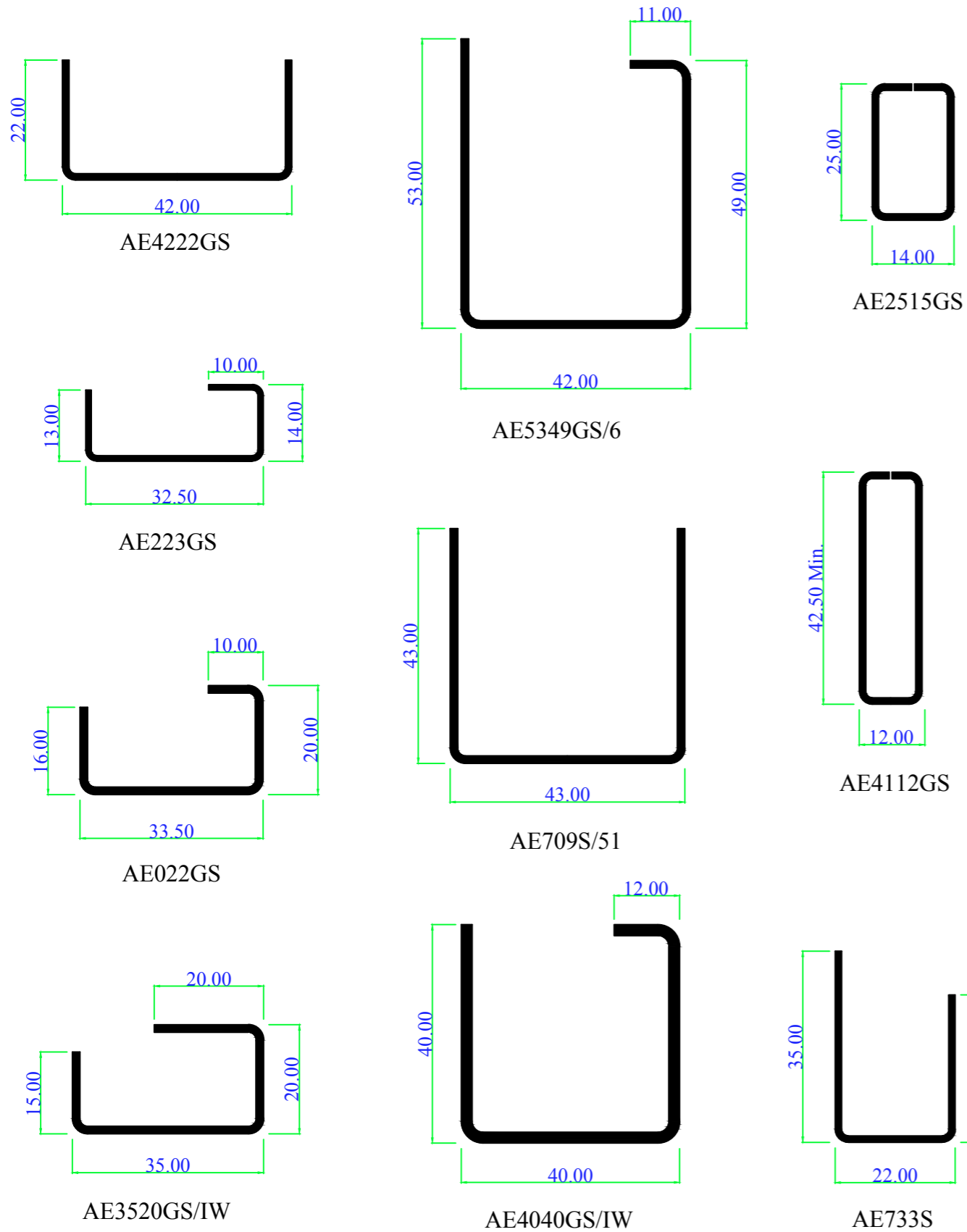

General Profile Tolerance \pm C.5mm
 Angular Tolerance \pm 1.0 Deg
 Straightness Tolerance L/600
 Length Tolerance +10mm / -10mm

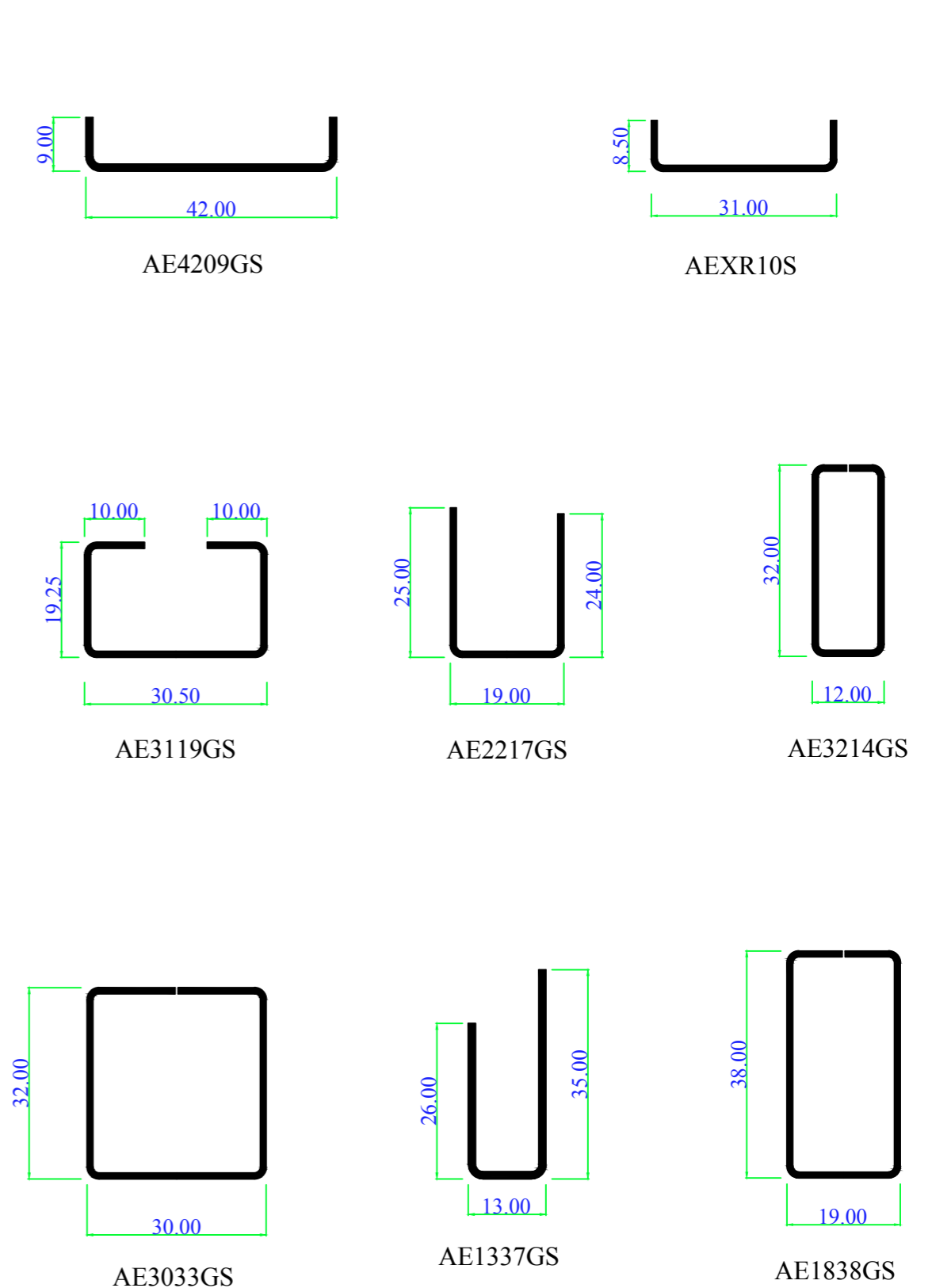

General Profile Tolerance \pm C.5mm
 Angular Tolerance \pm 1.0 Deg
 Straightness Tolerance L/600
 Length Tolerance +10mm / -10mm

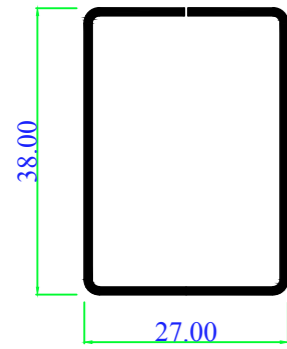

AE4GS

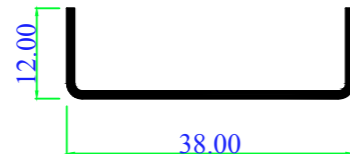

AE3812GS

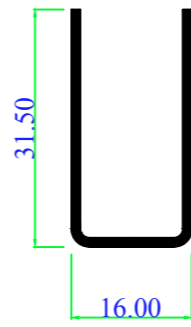

AE1631GS

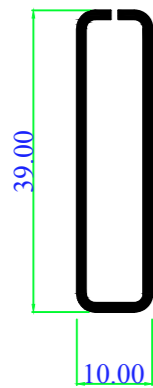

AE4010GS

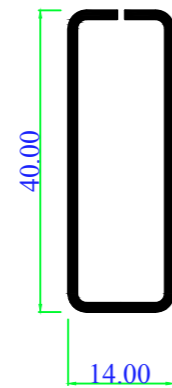

AE1540GS

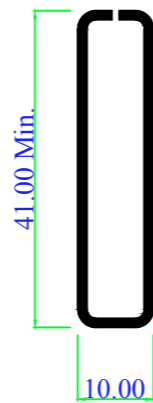

AE4210GS/IW

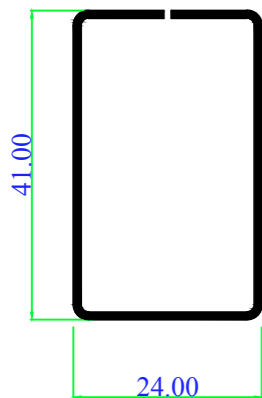

AE4224GS

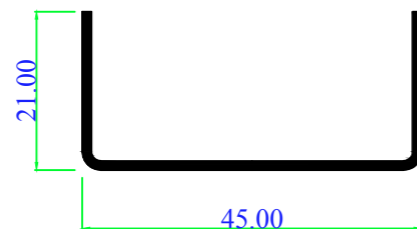

AE702LS

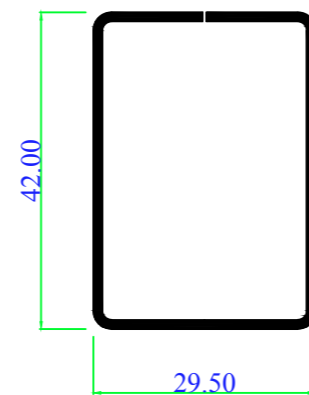

AE4230GS/IW

General Profile Tolerance \pm C.5mm
 Angular Tolerance \pm 1.0 Deg
 Straightness Tolerance L/600
 Length Tolerance +10mm / -10mm

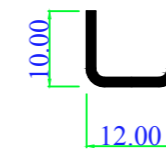

AE1210CS

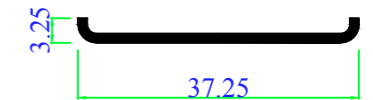

AEBR05S

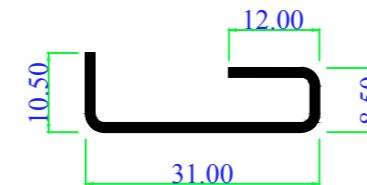

AEXR32S

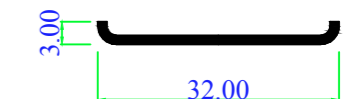

AE3203GS

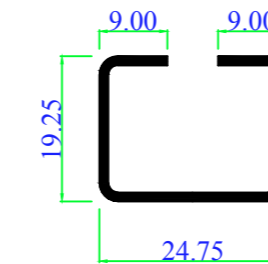

AR30S

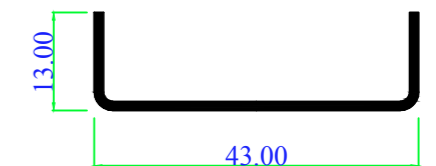

AE4313GS

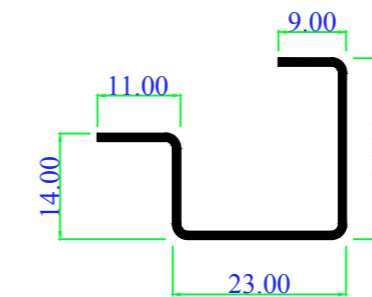

AE2324GS

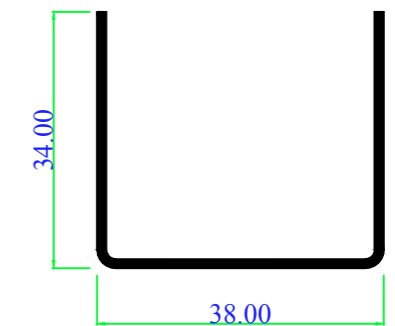

AE3834GS/57

General Profile Tolerance \pm C.5mm
 Angular Tolerance \pm 1.0 Deg
 Straightness Tolerance L/600
 Length Tolerance +10mm / -10mm

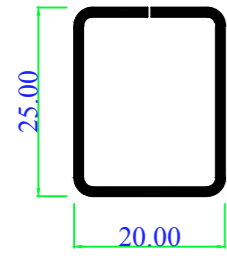

AE2520GS

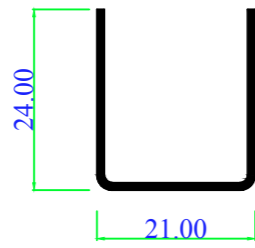

AE2025GS

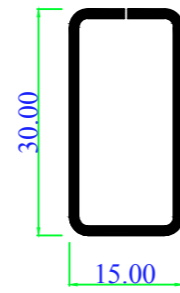

AE3015GS

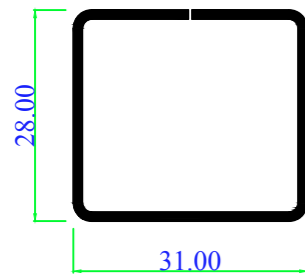

AE3129GS

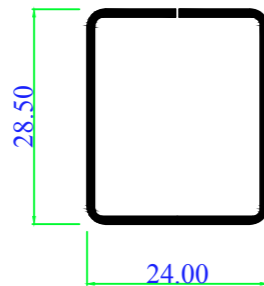

AE3025GS

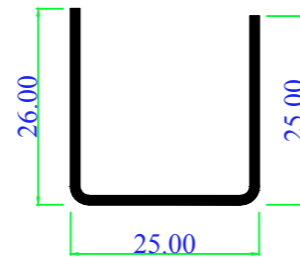

AE2627GS

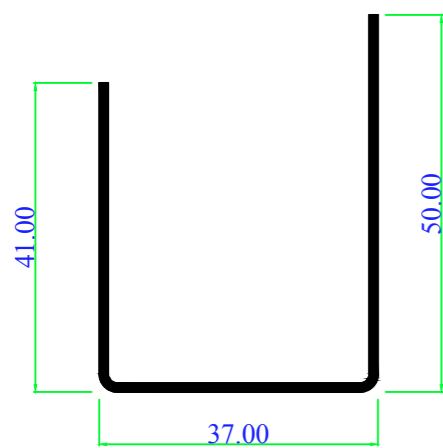

AE3750GS

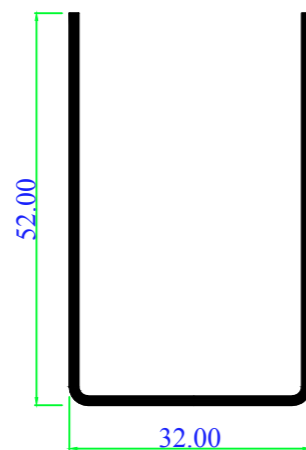

AE5233GS/54

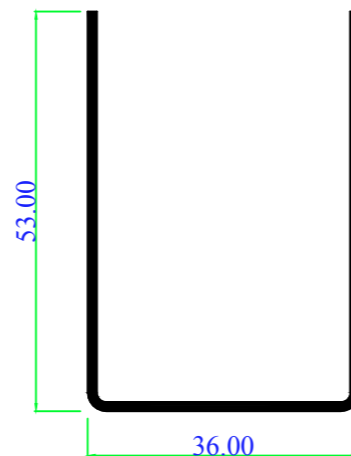

AE3454GS/54

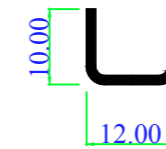

AE1210CS

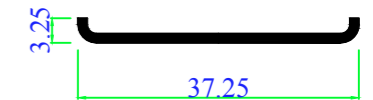

AEBR05S

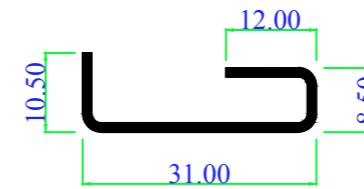

AEXR32S

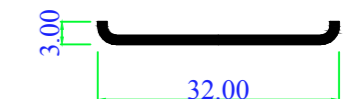

AE3203GS

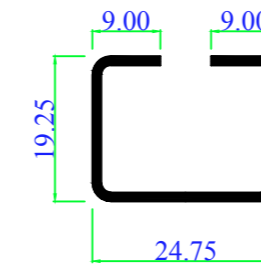

AR30S

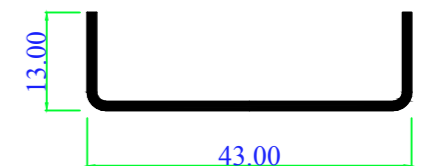

AE4313GS

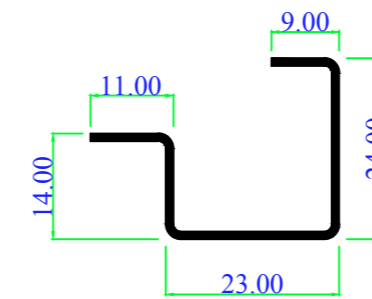

AE2324GS

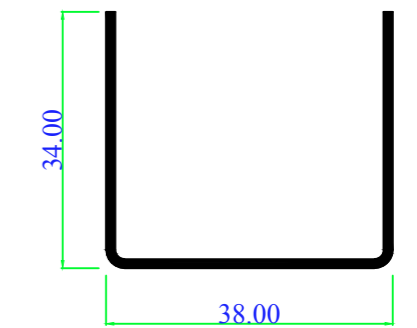

AE3834GS/57

General Profile Tolerance \pm C.5mm
 Angular Tolerance \pm 1.0 Deg
 Straightness Tolerance L/600
 Length Tolerance +10mm / -10mm

General Profile Tolerance \pm C.5mm
 Angular Tolerance \pm 1.0 Deg
 Straightness Tolerance L/600
 Length Tolerance +10mm / -10mm

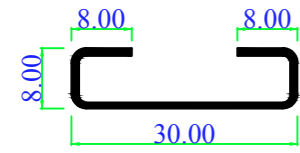

AE308GS /
AR10S

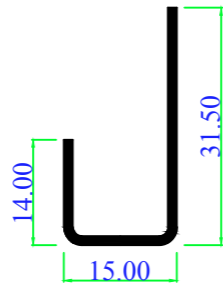

AE1616GS

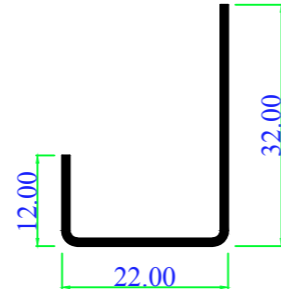

AE3222GS

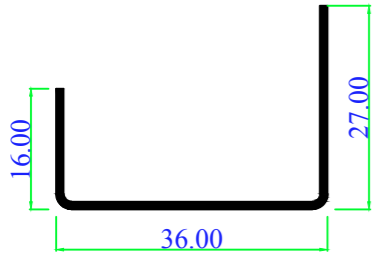

AE33GS

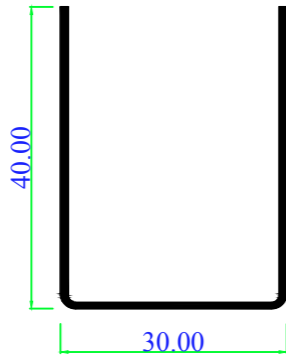

AE3040GS

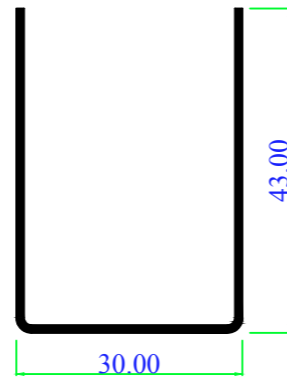

AR40S

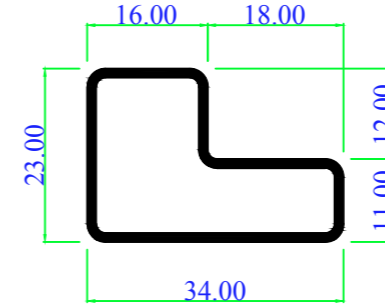

AE2316GS

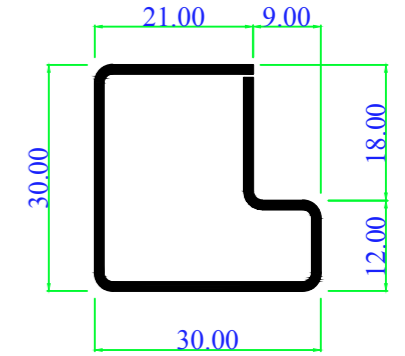

AE2490GS

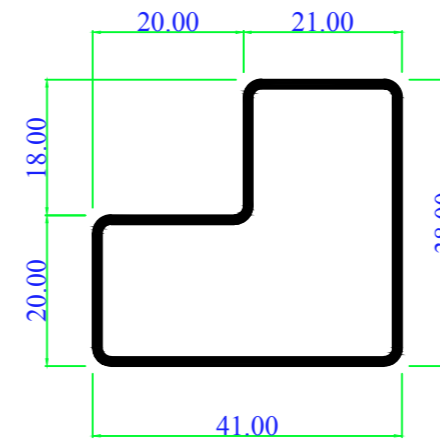

AE3841GS

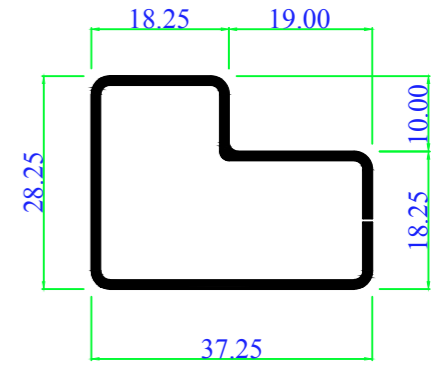

AE2837GS-B

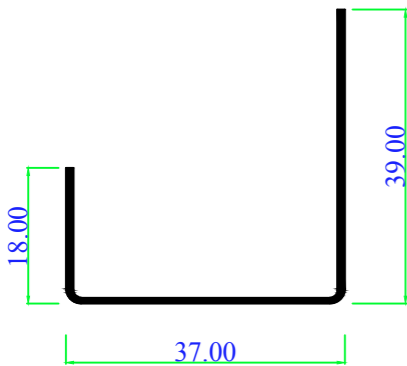

AE3937GS/5

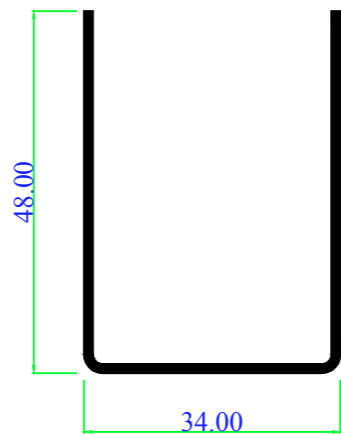

AE3448GS

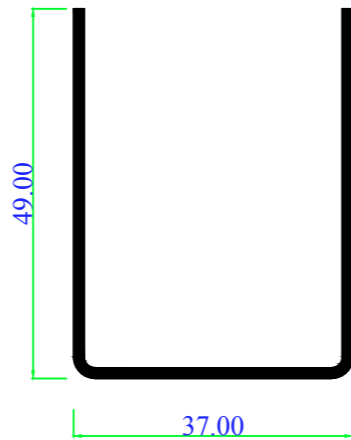

AE3749GS

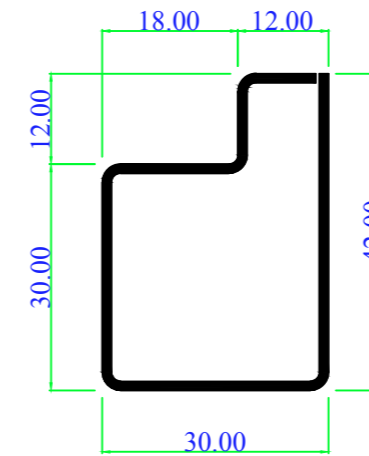

AE4230GS/EDGE

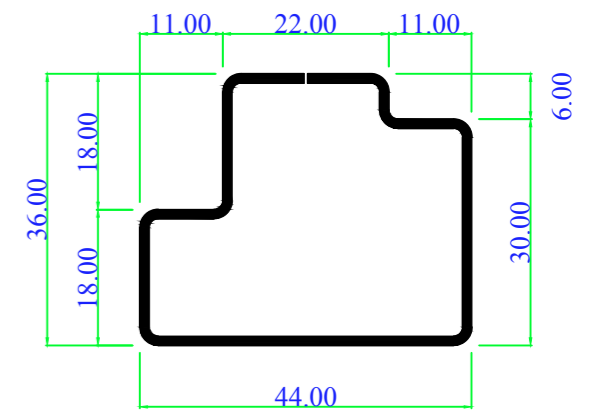

AE4436GS

General Profile Tolerance \pm C.5mm
Angular Tolerance \pm 1.0 Deg
Straightness Tolerance L/600
Length Tolerance +10mm / -10mm

General Profile Tolerance \pm C.5mm
Angular Tolerance \pm 1.0 Deg
Straightness Tolerance L/600
Length Tolerance +10mm / -10mm



TEL: 0161 231 2354

228 Briscoe Lane, Manchester, M40 2XG

www.anglo-european.net | sales@anglo-european.net



ANGLO EUROPEAN
IMPORT-EXPORT LTD